















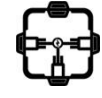

ΣΤΡΟΓΓΥΛΑ ΠΡΕΣΑΡΙΣΤΟ ΚΑΠΑΚΙ IP54
ROUND PRESS-ON LID IP54
Ø 80x40 ECO



ΤΕΤΡΑΓΩΝΑ ΠΡΕΣΑΡΙΣΤΟ ΚΑΠΑΚΙ IP54
SQUARE PRESS-ON LID IP54
80x80 ECO

TECHNICAL DATA SHEET

Directive	LVD 2014/35/EU			
Standards	EN 60670-1:2005+A1:2013 Boxes and Enclosures, Electrical Installations EN 60529 Degrees of Protection , Enclosures, IP Rate			
Halogen Acid Amount	EN 61034-2 :2005+A1:2013+AMD2:2019 EN 60754-1 :2014+A1:2020 - EN 60754-2 :2014+A1: 2020			
ECO Solution	Με χαμηλό περιβαλλοντικό αποτύπωμα συμβάλλοντας στην μείωση του CO ₂ και στην κατανάλωση ορυκτών καυσίμων. With a low environmental footprint contributing to the reduction of CO ₂ and the consumption of fossil fuels.			
Applications	Εξωτερική, Εσωτερική	Outdoor, Indoor		
Installations	Οικιακές, Βιομηχανικές, Επαγγελματικές Ηλεκτρολογικές Εγκαταστάσεις Residential, Industrial, Professional Electrical Installations			
Characteristics	Πλαστικό ανθεκτικό κουτί Διακλαδώσεων με πρεσαριστό κουμπωτό καπάκι Plastic Shockproof Junction box with Press-On Lid Με Εύκαμπτες τάτες εισόδου Σωληνώσεων, Εξαρτημάτων, Καλωδίων. With flexible Glands, entries for Accessories - Conduits - Cables			
Material	Modified Thermoplastic Polyolefin			
Specifications	IP Rate	54		
	Glow Wire Test	650 °C		
	UV Resistance	R		
	Chemicals Resistance	R		
	Dielectric Strength	400V		
	Temperature range	-25 °C	+90 °C	
	Color	Black		



**ΣΤΡΟΓΓΥΛΑ ΠΡΕΣΑΡΙΣΤΟ ΚΑΠΑΚΙ IP54
 ROUND PRESS-ON LID IP54**

∅ 80x40 ECO

TYPE	∅80x40 ECO
CODE	32-21080-804
A ∅_mm	80
B / mm	40
D Pipe Od ∅_mm	16/20
E Entries ∅_mm	23
COLOR	Black
PACKING/Carton Box_pcs	60

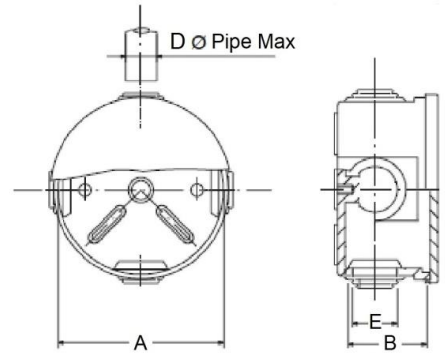

**ΤΕΤΡΑΓΩΝΑ ΠΡΕΣΑΡΙΣΤΟ ΚΑΠΑΚΙ IP54
 SQUARE PRESS-ON LID IP54**

80x80 ECO

TYPE	80x80 ECO
CODE	32-21004-808
A ∅_mm	80
B / mm	40
D Pipe OD ∅_mm	16/20
E Entries ∅_mm	23
COLOR	Black
PACKING/Carton Box_pcs	60

